



THE CANSAT BOOK





THE CANSAT BOOK

The CanSat book has been created for the Dutch CanSat Competition.

This tutorial shows how to build a basic CanSat from scratch, using the ESERO NL CanSat-kit.

First we describe how to get the Arduino board up and running. Then we discuss the primary mission and how to make sure that you extract the necessary data.

Together with the Dutch CanSat Competition Guidelines, you now have all the information needed to start your CanSat project!

Colofon

The CanSat Book has been written by Frank Hagenaaers on behalf of ESERO NL. It is based on the work of Thomas Gansmoe, Stian Vik Mathisen and Jøran Grande from NAROM, together with Jens F. Dalsgaard Nielsen from Aalborg University and Nils Kristian Rossing from the Norwegian University of Science and Technology published at: esero.no/wp-content/uploads/2015/11/The-CanSat-Book-R2.12.compressed.pdf.

The CanSat kit used in this book has been developed by [Fun met Electronica](#) and is based on the NAROM CanSat Kit.

CanSat is an ESERO NL project, executed by NEMO on the instructions of the Netherlands Space Office (NSO).

Photography cover: DigiDaan.

Introduction to CanSat.....	5
What is a CanSat?	5
The CanSat kit.....	6
Contents of the kit.....	6
Arduino	8
Connecting the Arduino.....	9
Programming the Arduino	10
1. Blink.....	10
2. Measuring analog voltage with Arduino.....	11
3. Measuring light intensity and temperature	13
4. Measuring barometric air pressure and temperature with BMP280 module.....	14
5. Gathering data from the serial port	16
Assembly.....	18
Tools and requirements.....	18
The shield	19
1. Solder the pin headers onto the BMP280 sensor	19
2. Solder pin headers to the prototyping shield	21
3. Solder the power switch to the shield	23
4. Attach APC220 and BMP280 to the shield	24
5. Soldering the female pinheader to the shield	25
6. Solder the battery connector to the shield.....	25
7. Powering Arduino	26
8. Connecting the BMP280 to the shield	26
9. Connecting the APC220 to the shield.....	27
10. Connecting the shield to the Arduino board	28
Testing Arduino/BMP280	29
Setting up the APC220	30
Programming the transceivers to work with Arduino	30
Testing APC220.....	32
APC220 and CanSat	32
APC220 on ground station	34
Gathering data at your ground station	34
How to make an Arduino code for your missions.....	34
Back Ground Information	35
Altitude calculations	35
Antenna design.....	37

THE CANSAT BOOK

Modulation	37
APC220	37
Antennas	37
CanSat Antenna	38
Ground station antenna.....	38
Parachute design.....	39
Parachute production	39
Example assignments	39
Descent physics	39
Required descent parameters.....	40
Semi-spherical parachute design	41
Cross parachute design	41
Parapent.....	41
Flat parachute design.....	42
Other recovery systems	42
CanSat Competition tips.....	44
Outreach programme & communication	45
Public relations and free publicity.....	45
Basic information about the project & partners.....	45
Social Media	45
Website/blog.....	45
Press.....	45

Introduction to CanSat

What is a CanSat?

A Canned Satellite (CanSat) is designed to simulate a real satellite, integrating all the elements of a real satellite into a space the size of a soda can. The challenge for students is to fit all the major subsystems found in real satellites into this small volume including a propulsion system, sensors, and a communication system. When finished, the CanSat will be launched to an altitude of one kilometer by a delegated rocket to begin its mission, concluded with a safe landing. During the flight, the CanSat will use radio communication to transmit data to a ground station.





CanSats offer a unique opportunity for first-hand practical experience in space projects and the scientific experimentation process. The students will be responsible for all aspects of the project, including the design of the CanSat, selecting its missions, integrating the components and subsystems, testing and preparing for launch, and data analysis.



The CanSat kit

The CanSat kit used in the Dutch competition consists of an Arduino Uno R3 board and a universal prototyping shield.

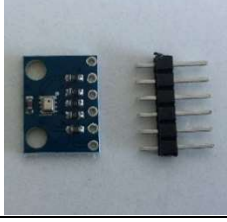
Contents of the kit

The kit contains all the electronic components necessary for the CanSat's primary mission.

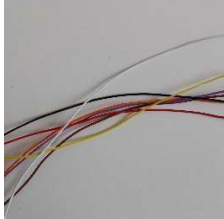
<p>Arduino Uno R3 (2x) The core of the Arduino system, which contains the microcontroller, I/O ports, etc.</p>	
<p>Universal prototyping shield The prototyping shield serves as the backbone of the system. It connects and holds all the parts together.</p>	
<p>APC220 Radio transmitter/receiver (transceiver) The transceiver is used to transmit/receive radio signals between the ground station and the CanSat.</p>	
<p>BMP 280 Module This sensor module measures Barometric pressure and temperature</p>	
<p>Male header</p>	
<p>Female header</p>	

<p>Battery connector</p>	
<p>Several different colour wires</p>	
<p>CanSat assembly kit This kit contains all the parts required for the structure of the CanSat</p>	

The prototyping shield is designed to fit on top of the Arduino board. More information can be found at: <https://shop.funmetelectronica.nl/product-categorie/cansat/>

Arduino

To carry out its primary mission during descent, the CanSat has to measure barometric air pressure and temperature. The relevant sensors must be connected to an Arduino board. The Arduino board processes the sensor signals. The data Arduino produces is sent by radio signals to a ground station .

You will use this as the core of the CanSat.

Arduino is an open-source electronics platform based on easy-to-use hardware and software. Arduino boards are able to read inputs from a sensor and turn them to output. You can instruct your board on what to do by sending a set of instructions to the microcontroller on the board.

To get started with Arduino, follow these next steps.

First take a close look to the Arduino R3:

USB: The USB connection can do two things. Firstly, it can provide power to the Arduino from the computer. Secondly, it can communicate with the computer.

TX/RX: If effective uploading and communication cannot be achieved through the USB port, pins D0 and D1 can also be used.

Power in: If the USB is not used as a power supply, the power jack (5.5mm-2.1mm) or the power pins Vin and GND can be used. Arduino can manage power with a range of 5-20V.

Power out: Powering the external components can be done via the power pins 5V and 3.3V. The maximum current is 1A.

Analog in: Arduino can read analogue voltage from 0V to 5V.

Digital in/out: These pins can be declared as input pins or output pins. If used as an input pin, it can read input voltage: <2.5V is LOW, >2.5V is HIGH. When using it as an output pin, LOW is 0V, HIGH is 5V. Pin 3, 5, 6, 9, 10 and 11 can provide a PWM signal.

You can program the Arduino with Arduino IDE. You can download Arduino IDE at www.arduino.cc/en/Main/Software

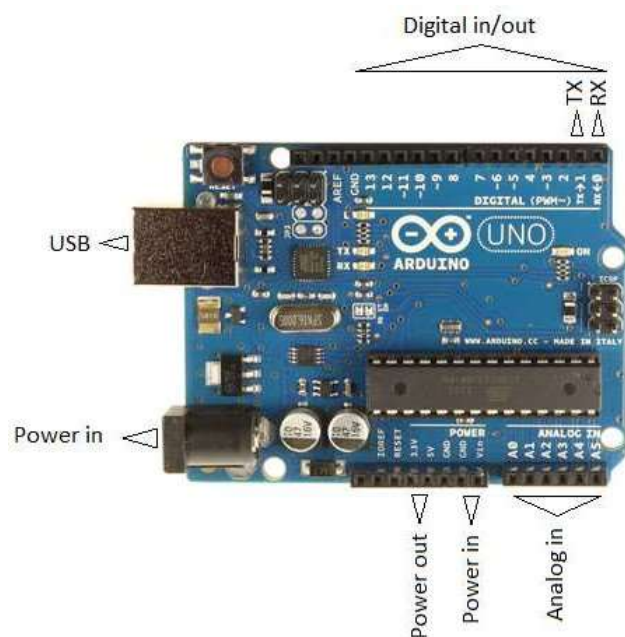

Connecting the Arduino

Make sure you installed Arduino IDE properly. Open Arduino IDE and connect the Arduino UNO by USB. If drivers are properly installed, the computer recognises the Arduino board.

Go to 'Hulpmiddelen' and connect the COM-port of the Arduino board by following the figure below.

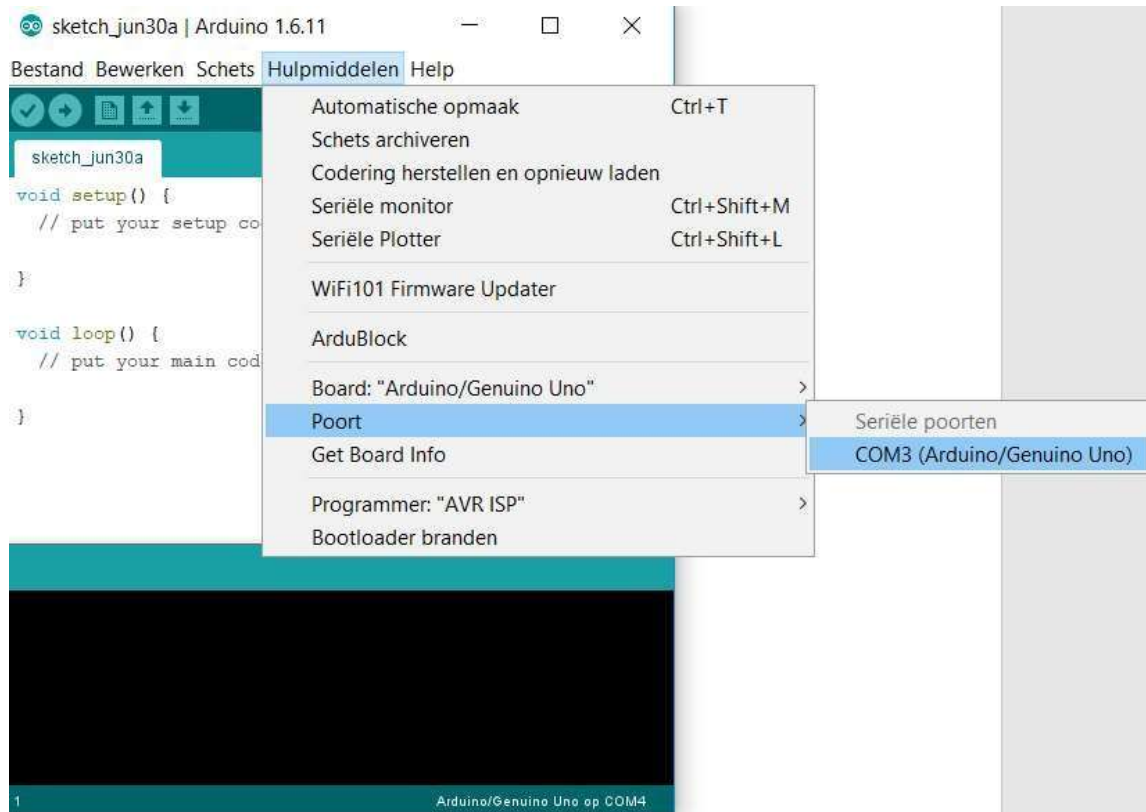

In this example, it is COM3.

Programming the Arduino

The first sketch in Arduino is 'Blink'.

You can find 'Blink' on 'Bestand > Voorbeelden > Basic > Blink'.

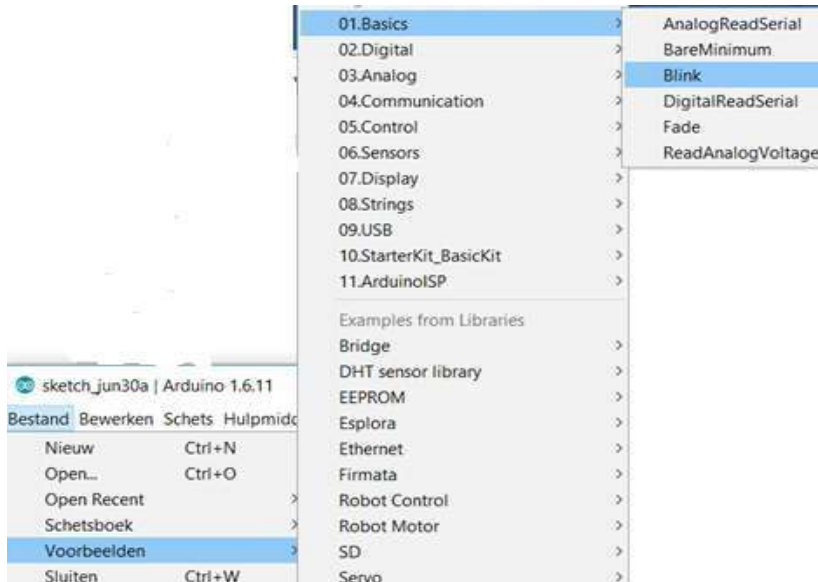

Read the text from this sketch.

1. Blink

Turns on an LED for one second, then off for one second, repeatedly. Most Arduinos have an on-board LED you can control. On the Uno, it is attached to digital pin 13.

```
// the setup function runs once when you press reset or power the board
void setup() {
  // initialize digital pin 13 as an output.
  pinMode(13, OUTPUT);
}
// the loop function runs over and over again forever
void loop() {
  digitalWrite(13, HIGH); // turn the LED on (HIGH is the voltage level)
  delay(1000);           // wait for a second
  digitalWrite(13, LOW); // turn the LED off by making the voltage LOW
  delay(1000);           // wait for a second
}
```

When pressing Upload, you can see the upload progress at the right bottom.



Try to speed up the blinking LED. Each time you make a change to the code, do not forget to upload the new code. The new code overwrites the old code in the Arduino.

2. Measuring analog voltage with Arduino

The second sketch is 'ReadAnalogVoltage'. The illustration shows you how to find this sketch:

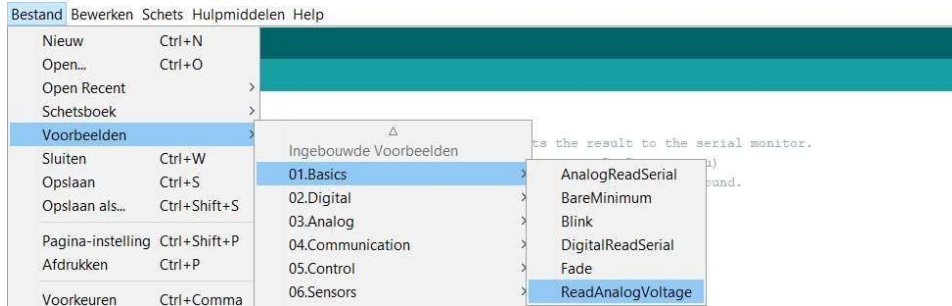

For this sketch, you need to apply external components. In an experimental setting, you can use a breadboard and jumper wires. Most components can be placed directly on the breadboard. To generate a variable voltage, you have to use a 10K Ω potentiometer. See picture below.

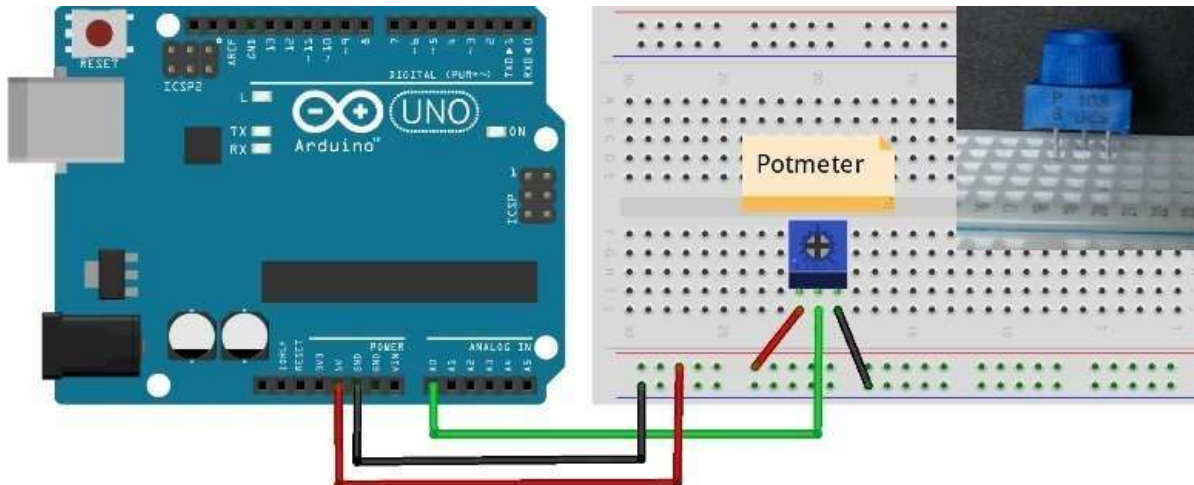

Let's take a look at this sketch:

ReadAnalogVoltage

Reads an analog input on pin 0, converts it into voltage and prints the result to the serial monitor. Graphical representation is available using serial plotter (Tools > Serial Plotter menu).

Attach the centre pin of a potentiometer to pin A0 and the outside pins to +5V and ground.

```
// the setup routine runs once when you press reset:
void setup() {
  // initialize serial communication at 9600 bits per second:
  Serial.begin(9600);
}

// the loop routine runs over and over again forever:
void loop() {
  // read the input on analog pin 0:
  int sensorValue = analogRead(A0);
  // Convert the analog reading (which goes from 0 - 1023) to a voltage (0 - 5V):
  float voltage = sensorValue * (5.0 / 1023.0);
  // print out the value you read:
  Serial.println(voltage);
}
```

Do not forget to turn on the serial monitor (button on the top-right).



When you are running this sketch on the Arduino, you can read the voltage on the serial monitor. Try to change the speed of measuring the values on A0. Create a delay of 1000 milliseconds.

You can see the values in the serial monitor.



Using the potentiometer, you can make any voltage on the centre pin between 0 – 5V. The main resistor of 10K Ω is cut into two pieces, the ratio of these two pieces can be adjusted by turning the potentiometer. In this way, you can provide a voltage between 0 – 5 V on the centre pin.

Learn more about a voltage divider at: https://en.wikipedia.org/wiki/Voltage_divider

We can do more with this knowledge.

3. Measuring light intensity and temperature

If we use one fixed resistor and one variable resistor, we can make a variable voltage. With a LDR (light depending resistor), we can measure light intensity and with a NTC or PTC, we can measure temperature.

Keep the same code (ReadAnalogVoltage) and make a new circuit with the LDR and NTC.

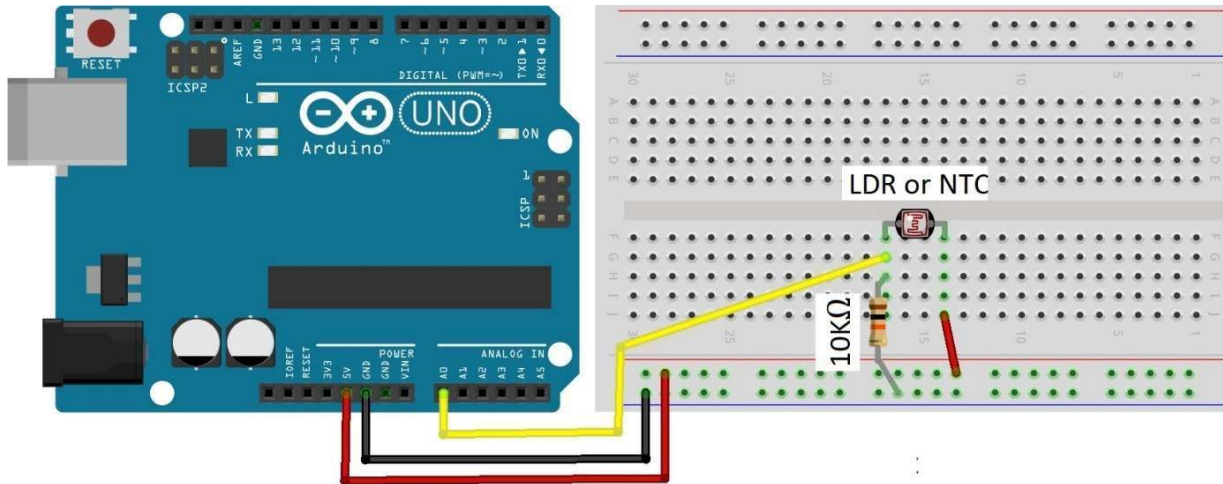

Measure light intensity and temperature. Try to change the code to adapt the values in the serial monitor.

4. Measuring barometric air pressure and temperature with BMP280 module

In the primary mission, your job is to measure barometric air pressure and temperature. The CanSat kit contains a module, the BMP280. This module can measure pressure and temperature. The working voltage of this module is 3.3 V. Check this in the wiring diagram. If you want to use it with the Arduino IDE, you will need a library. The Arduino IDE can be extended through the use of libraries to provide extra functionality to your sketches. Most libraries come with example sketches. You can find the libraries in the [CanSat download files](#). Copy the folder “Adafruit_BMP280” and “Adafruit_Sensor-master” into the “libraries” folder in “Arduino” – “My Documents”, Exit and restart Arduino IDE.

You can now find the example sketch *bmp280test*:

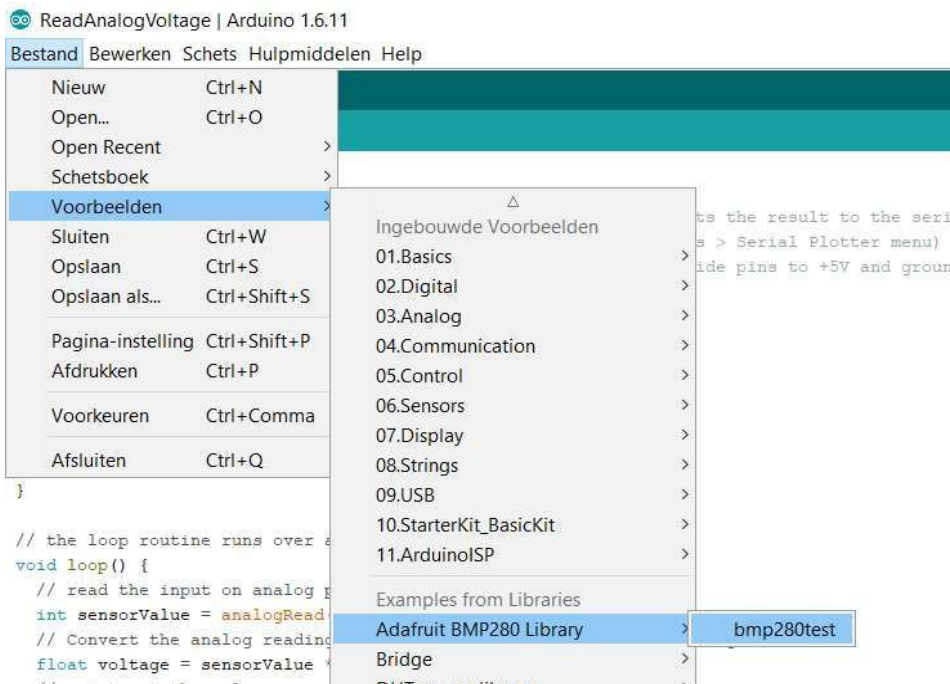

Wire the BMP280 module:

- | | |
|------------|------|
| 1. VCC | 3.3V |
| 2. GND | GND |
| 3. SCK/SCL | D13 |
| 4. SDA/SDI | D11 |
| 5. CSB | D10 |
| 6. SDO | D12 |

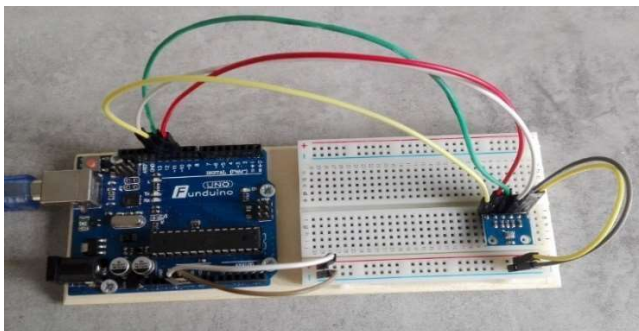

THE CANSAT BOOK

In the sketch, you have to 'double forward slash' and 'unslash' some lines.

```
#define BMP_CS 10

Adafruit_BMP280 bmp; // I2C
//Adafruit_BMP280 bmp(BMP_CS); // hardware SPI
//Adafruit_BMP280 bmp(BMP_CS, BMP_MOSI, BMP_MISO, BMP_SCK);

void setup() {
```

To:

```
#define BMP_CS 10

//Adafruit_BMP280 bmp; // I2C
//Adafruit_BMP280 bmp(BMP_CS); // hardware SPI
Adafruit_BMP280 bmp(BMP_CS, BMP_MOSI, BMP_MISO, BMP_SCK);

void setup() {
```

Now you can upload the sketch and open the serial port.



5. Gathering data from the serial port

If you want to use the data from the serial port, you can gather the data by using “CoolTerm”. CoolTerm is a simple serial port terminal application that is able to exchange data with hardware connected to serial ports such as microcontrollers (Arduino Uno).

You can download it at freeware.the-meiers.org/. You can choose the download file for your operating system.

If you connect the Arduino Uno with the BMP280 sensor and example sketch, you can get the data via CoolTerm. First you must set the properties for the connection.

Go to: Connection > Options.

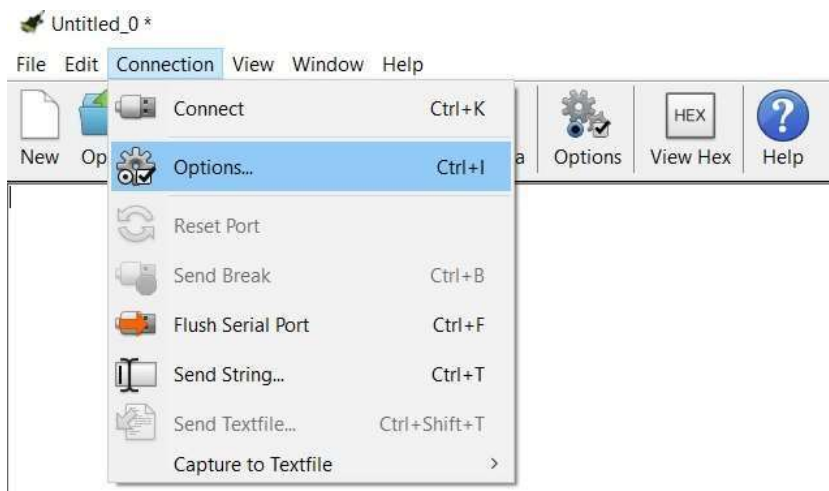

Press the button “Re-Scan Serial Ports”. In the dropdown menu “Port”, choose the com-port of your Arduino Uno and click OK. You can now hit the button “Connect” in the main dashboard.

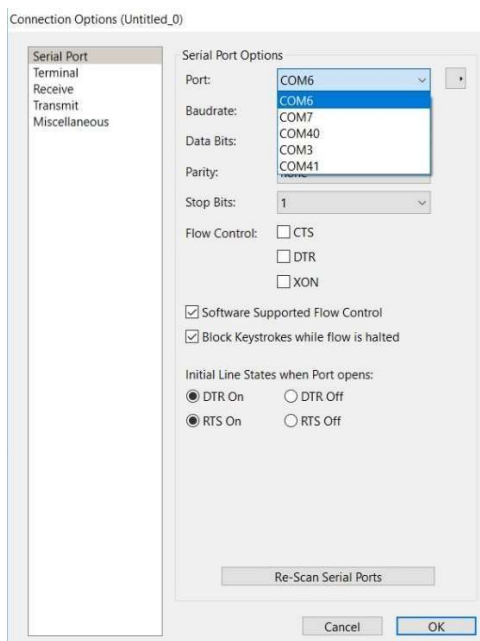

THE CANSAT BOOK



```
Temperature = 52.75 *C  
Pressure = 94762.39 Pa  
Approx altitude = 561.30 m
```

```
Temperature = 52.76 *C  
Pressure = 94766.95 Pa  
Approx altitude = 560.90 m
```

```
Temperature = 52.77 *C  
Pressure = 94772.58 Pa  
Approx altitude = 560.40 m
```

You can save this data to a text file. Go to: Connection > Capture to Textfile > Start. The text file can be imported into Excel or other spreadsheet software. If you want to use the data more easily, you can change the code in the sketch first.

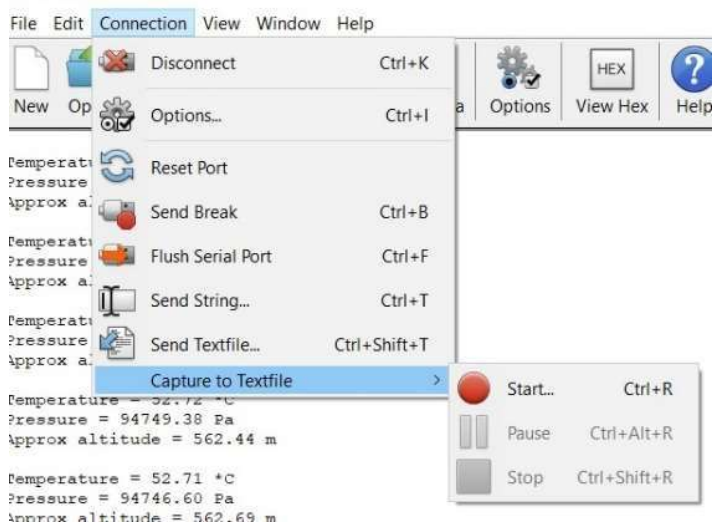

Note: If you want to use “CoolTerm”, you have to close the serial monitor on the Arduino IDE, because only one program can connect to a serial port at one time.

Assembly

By following these guidelines, you can assemble the prototyping shield. This shield keeps the main components together. For your primary mission you will need a:

1. External power source
2. Power switch
3. Radio transmitter
4. Temperature sensor
5. Pressure sensor

Tools and requirements

The tools required to assemble are those required for soldering hobby electronics. We recommend using the following equipment during the assembly process:

- Pliers
- Soldering iron and solder. It is important that the solder contains a flux core (this will facilitate the soldering).
- Optional but recommended: flux remover (to clean flux residue).
- Optional: a third hand, which is very convenient if you'd otherwise be alone while doing the assembly.
- Optional: a solder wick remover in case you make a mistake and want to unsolder the components.
- Optional: extra flux (e.g. in a pen dispenser). This element is optional but can help soldering the voltage regulator, which is surface mounted.



Third hand

Note: The assembly requires basic soldering skills. Be careful though, you are working with pretty delicate electronics. If you do not have much experience with soldering microelectronics, you should practice first before you start soldering the CanSat components to the prototyping shield. Consult these suggested tutorials to familiarise yourself with soldering if needed:

Short but very informative soldering tutorial: www.youtube.com/watch?v=f95i88OSWB4

Extended soldering tutorial:

Part 1 - Tools: www.youtube.com/watch?v=J5Sb21qbpEQ&feature=youtu.be

Part 2 - Basic techniques: www.youtube.com/watch?v=fYz5nIHH0iY&feature=youtu.be

Part 3 - Surface Mount: www.youtube.com/watch?v=b9FC9fAlfQE&feature=youtu.be

The shield

The final product we will be working towards will look like this:

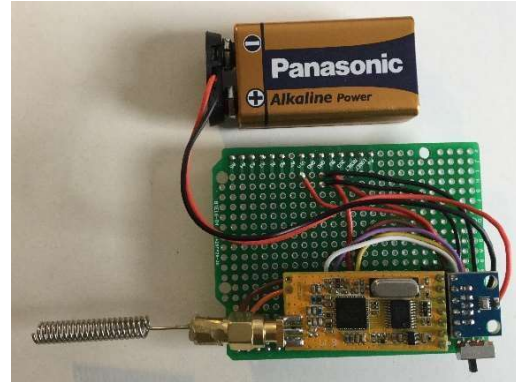
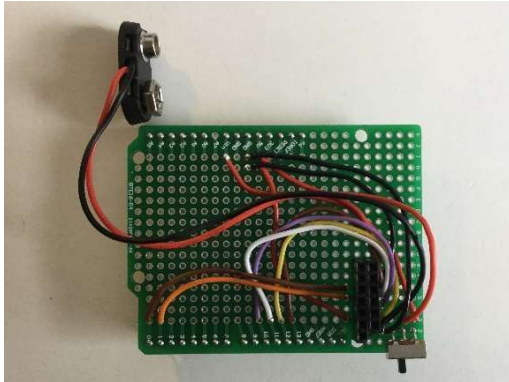
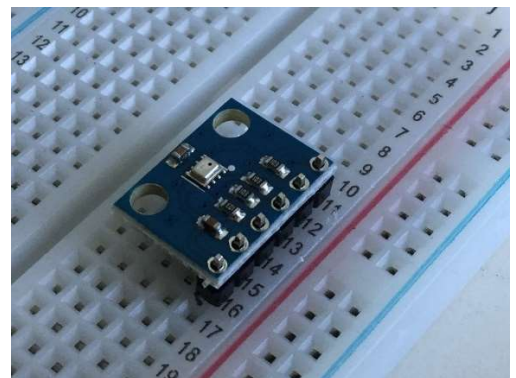
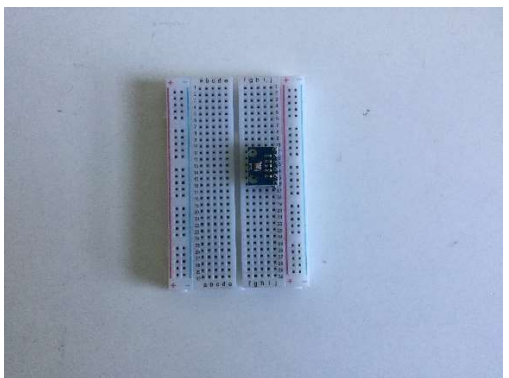
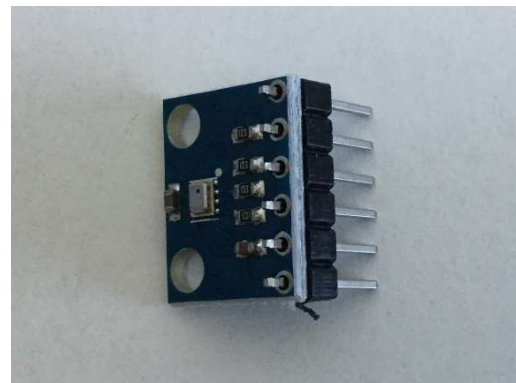
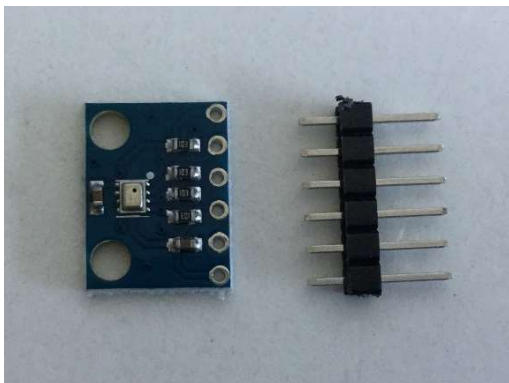

Figure: The shield is mounted on top of the Arduino UNO board. The battery holder, power switch, the transceiver (APC220) and the pressure/temperature sensor (BMP280) are mounted on top of the shield.

1. Solder the pin headers onto the BMP280 sensor

We will be soldering the headers to the BMP280 sensor. Use the male pin headers included in the plastic bag in your start kit. Place the shorter ends of the headers through the holes.



THE CANSAT BOOK

Place the pin headers and the BMP280 on a breadboard.

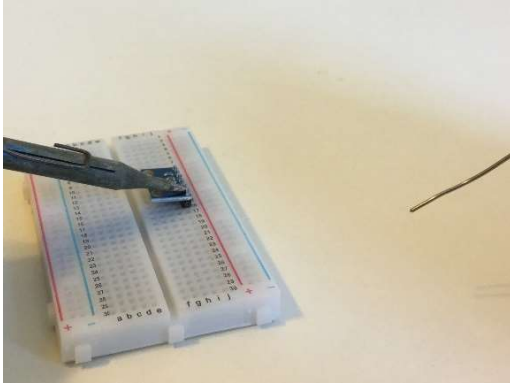

Preheat the two components briefly

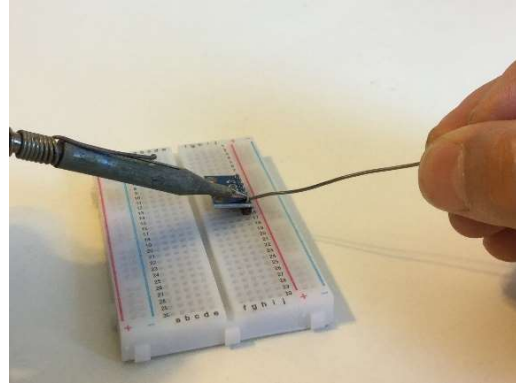

Add a small amount of solder

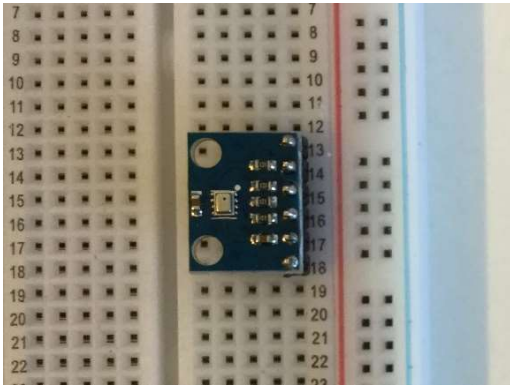

Done! Next step

2. Solder pin headers to the prototyping shield

Now that you have had some practice in soldering headers, solder the headers of the prototyping shield. Use the male headers. These have to be cut apart into 4 blocks; 1 x 6 pins, 2 x 8 pins and 1 x 10 pins.

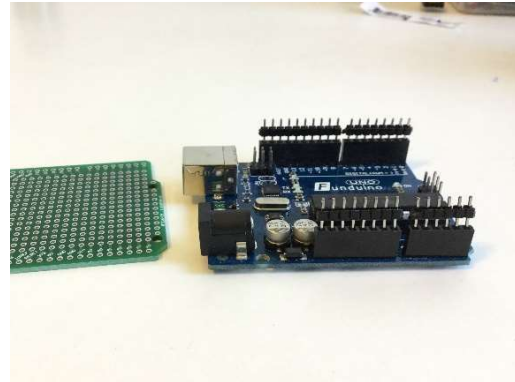
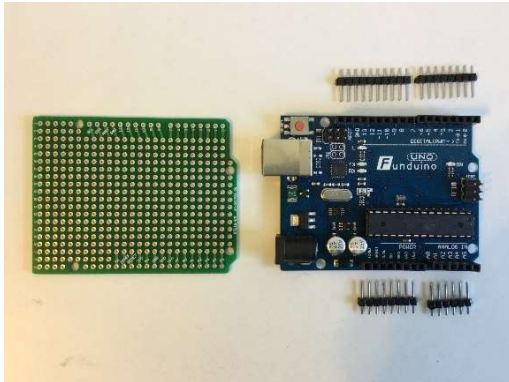
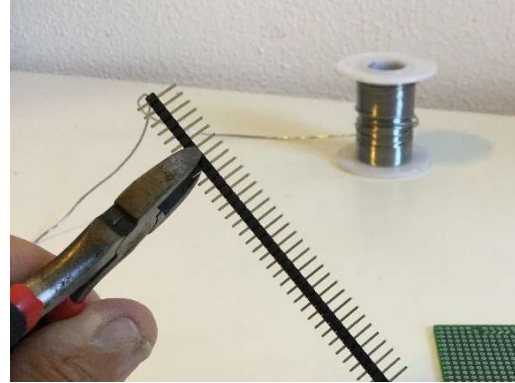
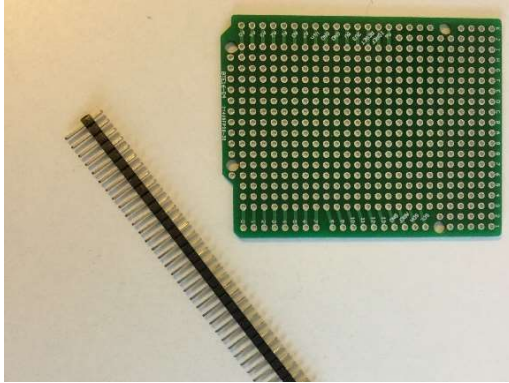

The long part of the pins needs to be placed through the Arduino UNO board.

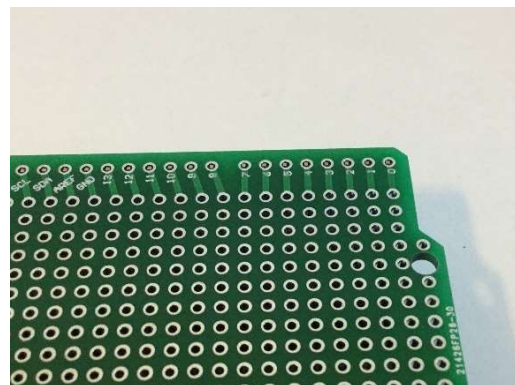
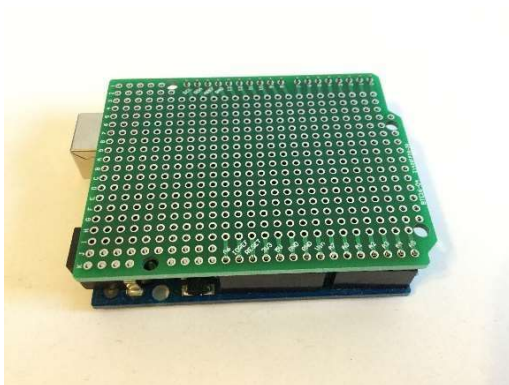

Place the shield on top of it. Adjust the top of the pins so that they are aligned with the top of the shield.

Note: the text printed on the shield is on top.

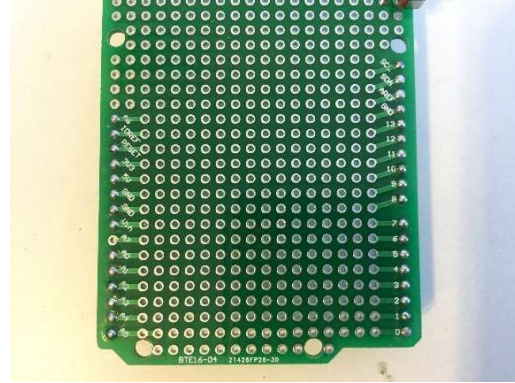
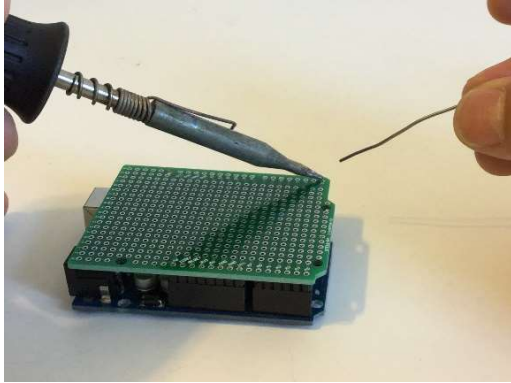

Solder the pins to get something like the shield above.

The pins on the Arduino are now attached to the shield. You can see through the shield which pins are connected to which holes. The rest of the holes are not connected to other holes. If you want, you may have to wire it yourself.

Take a look at the shield. The holes are placed in a grid of 0.1" (2.45mm).

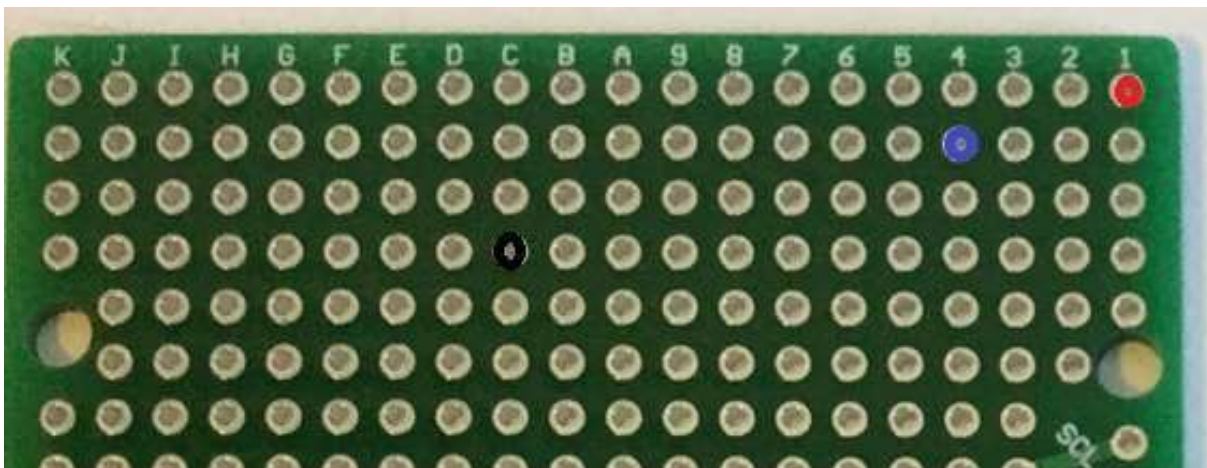

The red hole is on position (1,1), blue (4,2) and black (C,4).

3. Solder the power switch to the shield

The next step involves the power switch.

In order to solder the power switch on holes (2,1), (2,2) and (2,3) you must bend the switch's pins. This will allow you to solder the switch onto the top of the shield.

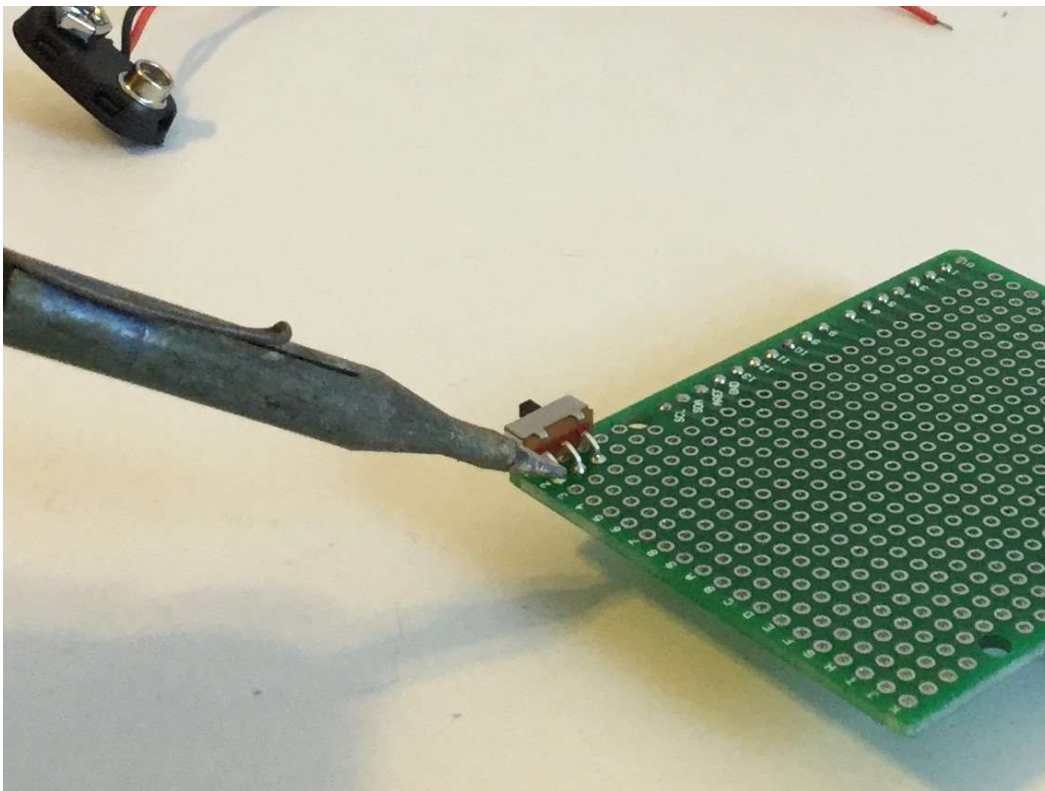
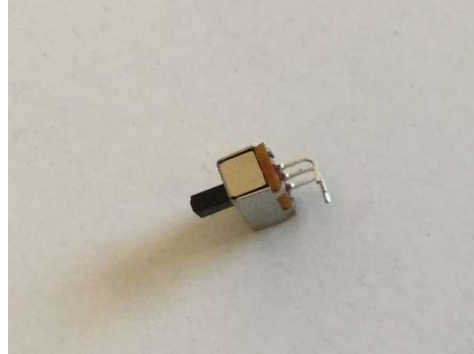

4. Attach APC220 and BMP280 to the shield

To attach the transceiver APC 220 and the BMP280 to the shield, you need to solder two female pinheaders: 1 x 6 pins and 1 x 7 pins. First you have to cut/break the pinheaders. Before you can break the pinheaders, you have to make a cut, so it breaks at the right place. Note that you'll lose one pin by breaking the header. You can make the cut with a sharp knife. Cut the header on both sides before breaking. Clean the edge with the same knife.

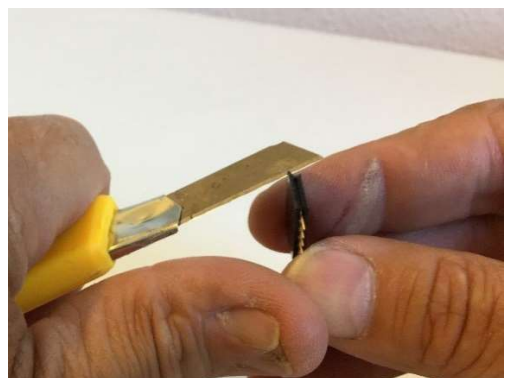
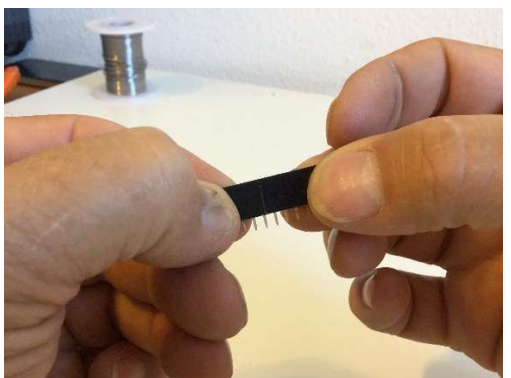
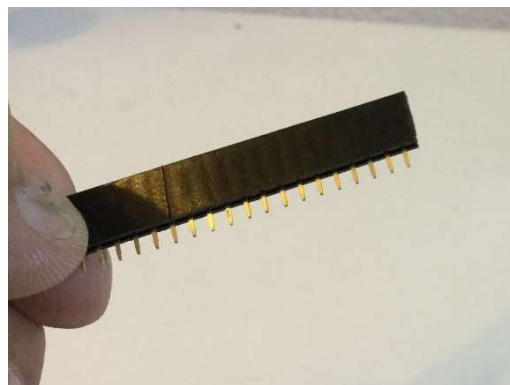
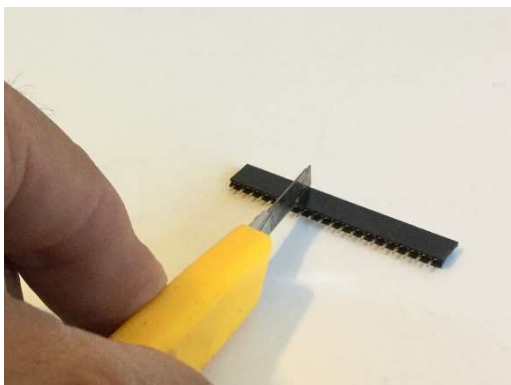
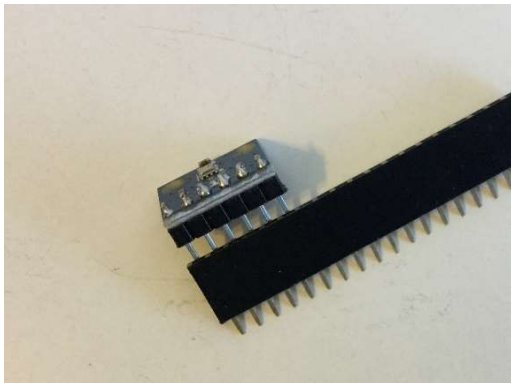

5. Soldering the female pinheader to the shield

The positioning of the headers is very important and the layout of the shield is tight. The 7 pinheader is for the APC220. Its position is from (2,6) to (8,6). The 6 pinheader is for the BMP280. Its position is from (3,5) to (8,5). You can place the headers on top of the shield and solder it on the bottom side.

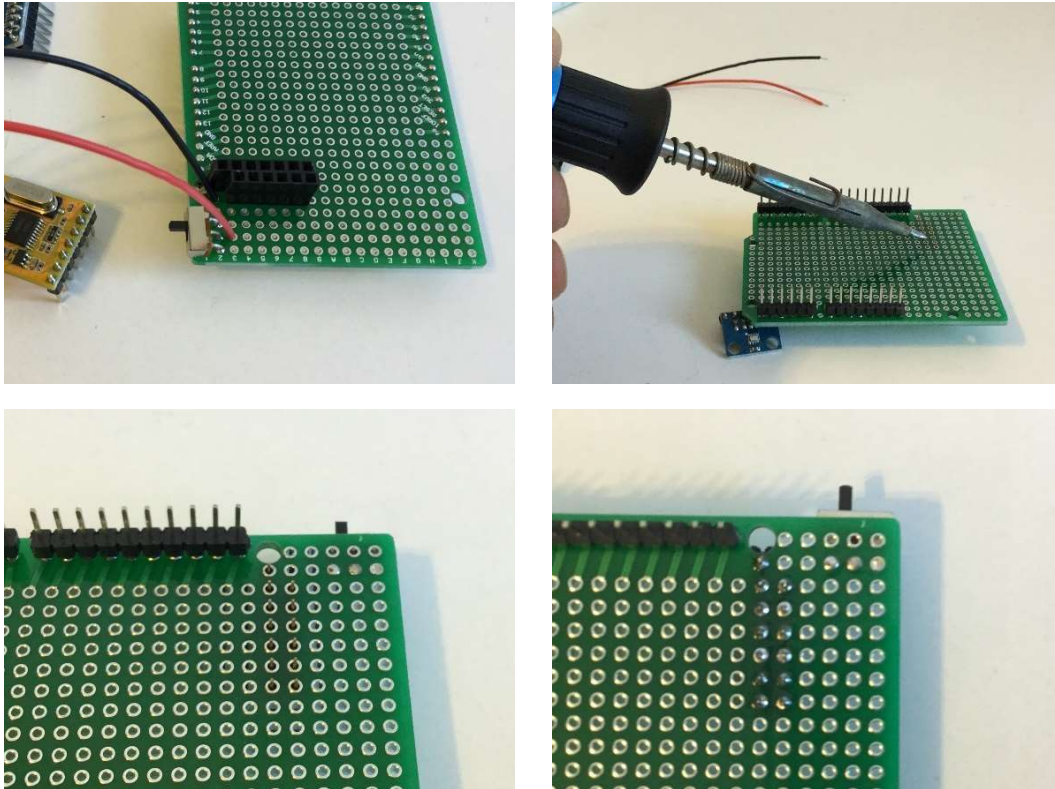

6. Solder the battery connector to the shield

The next component to be soldered to the board is the battery connector. This is also a tricky step since the board hole is bigger than the battery connector metal conductor. Use a third hand (or ask somebody to help you) to place everything in the right position and solder. Be careful not to burn your assistant with the soldering iron!

The red wire has to be positioned in (3,2). At the bottom side you have to connect the same wire with (2,2)! The black wire is positioned in (2,5). At the bottom side you have to connect the same wire with (2,6)!

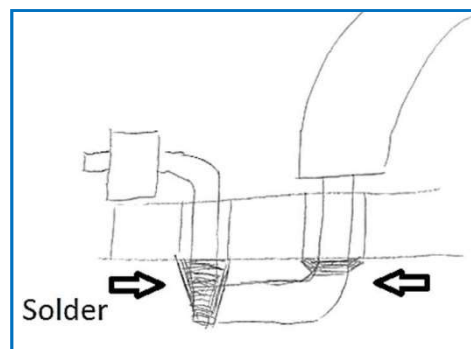
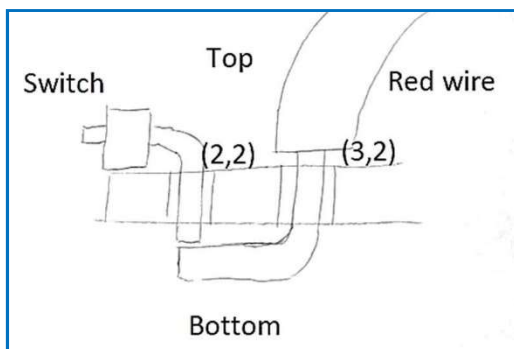

7. Powering Arduino

The power switch on the shield can turn the power from the battery to Arduino on and off. Arduino is powered by two pins: Vin and GND. You have to solder two wires: one red wire from the power switch ((3,1) top, (2,1) bottom) to Vin ((I,18) top), one black wire from ((2,4) top, (2,5) bottom) to GND ((I,17) top).

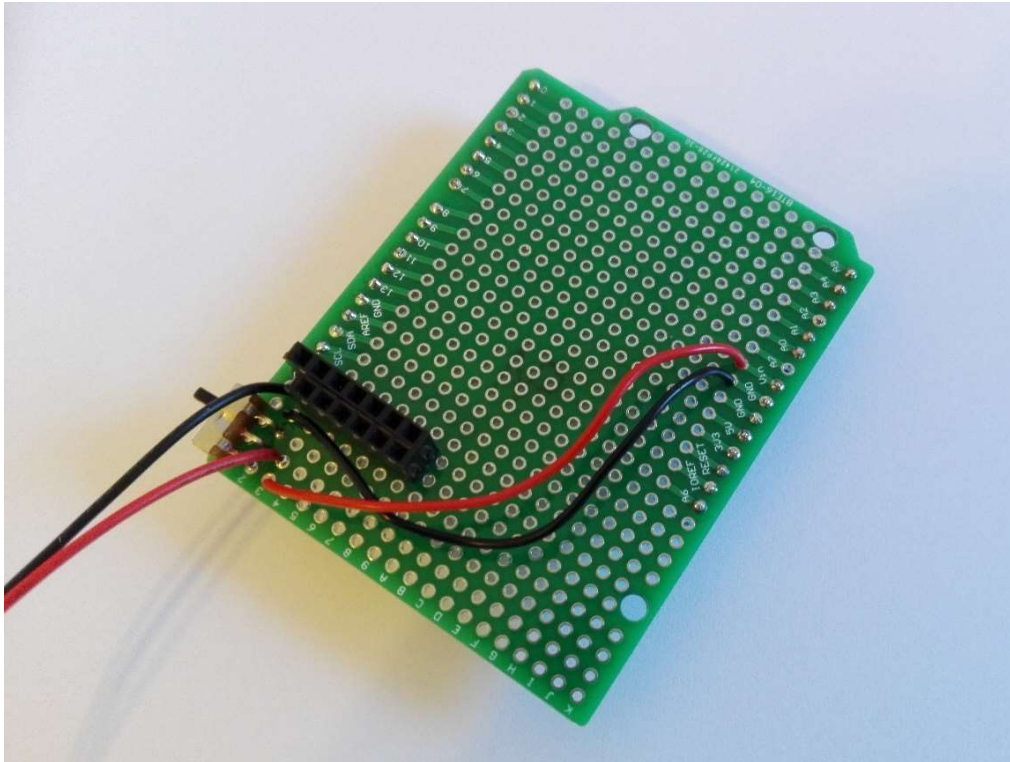

8. Connecting the BMP280 to the shield

You already used the sample code for BMP280. You can wire the BMP280 at the same pins. You can use 6 different colour wires.

BMP280	wire colour	top	down	Arduino	top	down
VCC	red	(8,4)	(8,5)	3.3V	(I,14)	N/A
GND	black	(7,4)	(7,5)	GND	(H,17)	(I,17)
SCK/SCL	brown	(6,4)	(6,5)	D13	(3,12)	N/A
SDA/SDI	white	(5,4)	(5,5)	D9	(3,16)	N/A
CSB	purple	(4,4)	(4,5)	D8	(3,17)	N/A
SDO	yellow	(3,4)	(3,5)	D12	(3,13)	N/A

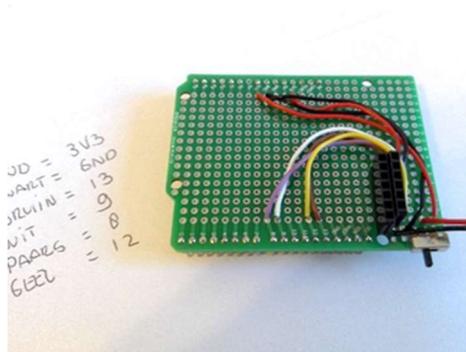
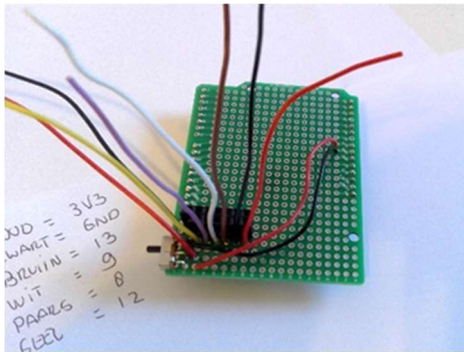

9. Connecting the APC220 to the shield

The 7 pin female header can only be wired with 4 wires; 3 should be left over. You can use any 4 different colour wires.

APC220	wire colour	top	down	Arduino	top	down	
SET	xxxx	xxxx	xxxx	xxxx	xxxx	xxxx	
AUX	xxxx	xxxx	xxxx	xxxx	xxxx	xxxx	
TXD	brown	(6,7)	(6,6)	RX/D10	(3,15)	N/A	
RXD	orange	(5,7)	(5,6)	TX/D11	(3,14)	N/A	
EN	xxxxx	xxxxx	xxxxx	xxxxx	xxxx	xxxxx	
VCC	red	(3,7)	(3,6)	5V	(1,15)	N/A	
GND	black	This wiring is combined with black wire battery holder					

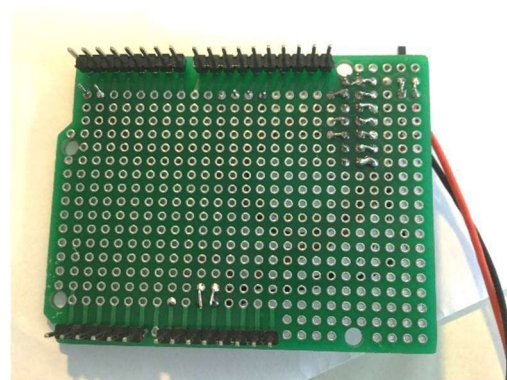
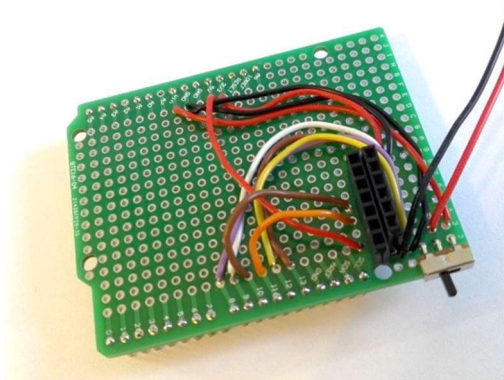

The shield is finished! How do you connect it to the Arduino board?

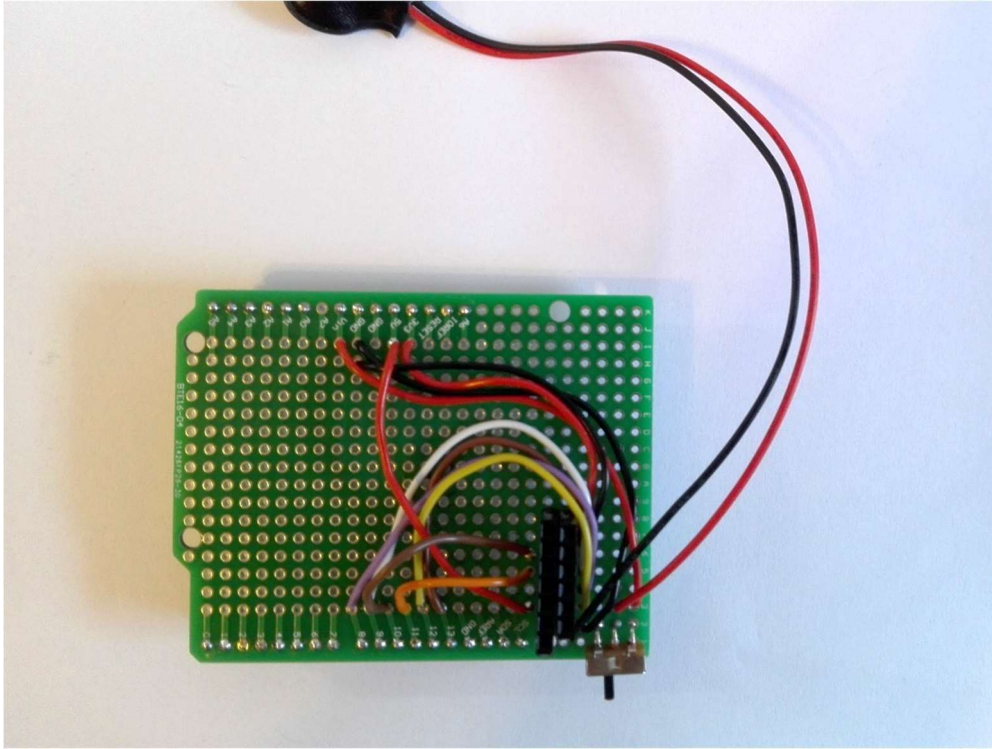

10. Connecting the shield to the Arduino board

Before you can connect the shield to the top of the Arduino board you have to check all the connections you've made. If you are sure everything is OK, you can go ahead and place the shield carefully on the Arduino. Once you've done this place the BMP280 module on top of it. **Do not place the APC220 and/or batteries on it! If you place a battery on it, make sure the power switch is in the top/off position.**

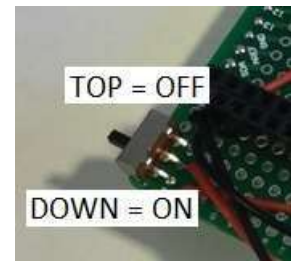

Testing Arduino/BMP280

Open the file bmp280test in Arduino IDE as shown below



First we make some changes to this sample file. We change the pin connections of D10 to D8 and D11 to D9:

```
#include <Adafruit_Sensor.h>
#include <Adafruit_BMP280.h>

#define BMP_SCK 13
#define BMP_MISO 12
#define BMP_MOSI 11
#define BMP_CS 10

Adafruit_BMP280 bmp; // I2C
```

To:

```
#include <Adafruit_Sensor.h>
#include <Adafruit_BMP280.h>

#define BMP_SCK 13
#define BMP_MISO 12
#define BMP_MOSI 9
#define BMP_CS 8

Adafruit_BMP280 bmp; // I2C
```

In the sketch, you also have to 'double forward slash' and 'unslash' lines.

```
#define BMP_CS 10

Adafruit_BMP280 bmp; // I2C
//Adafruit_BMP280 bmp(BMP_CS); // hardware SPI
//Adafruit_BMP280 bmp(BMP_CS, BMP_MOSI, BMP_MISO, BMP_SCK);

void setup() {
```

To:

```
#define BMP_CS 10

//Adafruit_BMP280 bmp; // I2C
//Adafruit_BMP280 bmp(BMP_CS); // hardware SPI
Adafruit_BMP280 bmp(BMP_CS, BMP_MOSI, BMP_MISO, BMP_SCK);

void setup() {
```

With the APC220 disconnected and the power switch in the off position, you can upload the BMP280 sample file to test a measurement in the serial monitor. If you close the serial monitor, you can also test the data in 'CoolTerm'.

Setting up the APC220

Telemetry is a technology that allows for the transmission of data from remote measurement devices. Information is transmitted wirelessly using radio waves. On the ground, these signals are collected by radio receivers. Telemetry is an essential part of satellite technology.

A transceiver is a device comprising both a transmitter and a receiver that are combined in a single housing.

In the CanSat program we use APC220, which is a transceiver with a highly versatile low power radio solution that is easy to set up, integrating seamlessly into any project requiring a wireless RF link.



You can connect one of these modules to your microcontroller on the CanSat and can connect your “ground station” APC220 module to a second microcontroller; this second microcontroller to be connected with your PC/Laptop.

Programming the transceivers to work with Arduino

To set up the APC220 first connect the Arduino board to the computer and upload the program “apc220cfg.ino” onto it. **Make sure you upload the program before you try to connect the transceiver to the Arduino board.** Disconnect the USB cable from the Arduino board and connect the transceiver to the Arduino as shown in the figure.

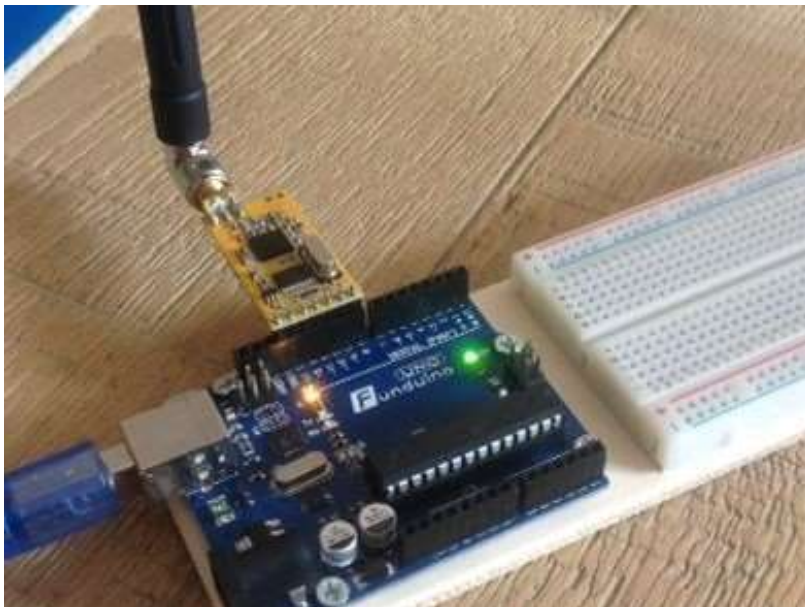

The transceiver will be connected to the pins labelled GND, 8,9,10,11,12 and 13 on the Arduino. Reconnect the Arduino board through the USB cable and open the Serial Monitor. In the command tab along the top type in ‘m’ and hit enter. This will bring up the menu shown in the figure.

```

COM10 (Arduino/Genuino Uno)
Verzenden

APC version: 101
Jul 30 2017

commands:
r : Read apc220 radio config
e : go into echo mode: receive char, add 1 and return
n : no more echo - back to normal
w : Write apc radio config ...
'W' FFFFFFF R P B C - number of letters indicates precise number of digits
FFFFFF: frequency: 434000 (434 MHz) range 418000-455000
R:      Rf data rate      - 1/2/3/4 equals 2400/4800/9600/19200bps
P:      Radio output power - 0 .. 9 9 equals 13dBm(20mW).
B:      UART baudrate    - 0/1/2/3/4/5/6 equals 1200/2400/4800/9600/19200/38400/57600bps
C:      Byte Chek Parity  - 0/1/2 equals NoCheck(8N1)/EvenParity(8E1)/OddParity(8O1)

Write example: w 434000 3 9 3 0 is...
434,000 MHz 9600 baud in air, 20mW, 9600baud on UART, No Parity(8N1)
After 30 seconds with no keyboard input we will emit a char every two second
    
```

If you type 'r' into this search bar and hit enter the program will return to the current configuration for the transceiver. To reconfigure the radio, type 'w' and the 5 parameters needed, with space between each parameter.

The first parameter will be frequency, range 418000 – 455000. For your CanSat, you will get your team frequency from the CanSat organisation. The figure shows an example list of frequencies.

Frequencies

Frequencies (MHz)	Team	Frequencies (MHz)	Team
433,050		433,950	
433,100		434,000	
433,150		434,050	
433,200		434,100	
433,250		434,150	
433,300		434,200	
433,350		434,250	
433,400		434,300	
433,450		434,350	
433,500		434,400	
433,550		434,450	
433,600		434,500	
433,650		434,550	
433,700		434,600	
433,750		434,650	
433,800		434,700	
433,850		434,750	
433,900		434,800	

The second parameter is RF data rate: 1/2/3/4 equals 2400/4800/9600/19200bps. The lower RF data rate increases the transmission range.

The third parameter is Radio output power. You'll likely see 0 .. 9. where 9 Equals 13dBm(20mW). 9 is its max power.

The fourth parameter is UART baudrate: the 0/1/2/3/4/5/6 you see there correlates with a bps of 1200/2400/4800/9600/19200/38400/57600bps. The baudrate should ideal be set to 9600 bps.

The last parameter is Byte Chek Parity: here 0/1/2 equals NoCheck(8N1) / EvenParity(8E1) / OddParity(8O1).

Note that you have to configure both transceivers with the same settings to be able to use them simultaneously.

Example entry: w 433100 3 9 3 0

Testing APC220

Finally, you can test the last electronic component of the CanSat kit: the APC220!!

APC220 and CanSat:

Connect the shield to the Arduino and connect the APC220 to the shield.



To do this open 'APC220_test' sketch. Let's take a look at this sketch.

```
#include <SoftwareSerial.h>
SoftwareSerial mySerial(10,11);//RX, TX
int number = 0;

void setup() {

  Serial.begin(9600);
  mySerial.begin(9600);

}

void loop() {
  (number ++);
  Serial.print ("APC220 test ");
  Serial.println (number);
  mySerial.print ("APC220 test ");
  mySerial.println (number);
  delay (1000);
}
```

Using Software serial, we can make a virtual serial port on pins we can choose. We can now upload and check whether the serial monitor works now that the APC220 is connected. Arduino will communicate with APC220 through pins 10 and 11. Because of this it will even be possible to display findings in the serial monitor information in a non-wireless way. The sketch displays 'APC220 test' and an increasing number. This data is sent to the serial monitor via USB (Serial), the same data is sent via APC220 (mySerial).

If you now upload the code and open the serial monitor you'll be able to see your text and numbers displayed in the monitor. Close the serial monitor, disconnect the Arduino USB connection and power the Arduino by battery. With the power switch in the 'ON' position, the sketch will run again on the Arduino and APC220 will transmit text and numbers.

THE CANSAT BOOK



APC220 on ground station:

Connect the second APC220 to the second Uno-this will be the "ground station-Uno"-and connect it to your computer.

Open the sketch "APC220_groundstation_UNO". Connect the APC220 as described in the sketch. Upload the sketch. If you are running the CanSat APC220 on battery, you can receive the test-data in the serial monitor of the ground station-Uno.

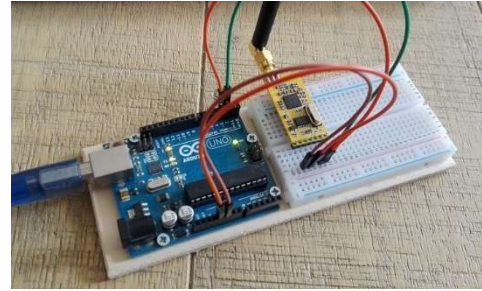

Gathering data at your ground station:

Close the serial monitor in Arduino IDE.

Open CoolTerm, select the right serial port and connect.

If your CanSat is transmitting and your second APC220 is connected, your ground station will receive data from it. In this case increasing numbers. Note that Coolterm can store data to a text file.

If you receive increasing numbers, your test has succeeded!

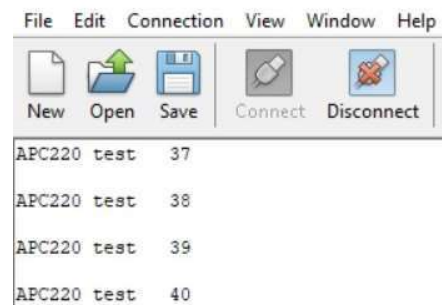

How to make an Arduino code for your missions

Now that you have completed the electronic components of the CanSat for your base mission, you're halfway done. This handbook does not provide the proper Arduino code for carrying out this mission fully. You have to make your own code for this by combining pieces of the code you used earlier. Try to keep the transmitted data to a minimum and try to prepare these data to import to Excel or other spreadsheet software. For instance: Use 'comma' or 'space' and 'new line' (println) in the data strings.

Finally: Note that several Arduino pins are not connected. If you choose to add more missions, you can use these pins. You can add the connections by soldering them to the shield.

Back Ground Information

Altitude calculations

The atmosphere is all around us. It is a thin gaseous layer surrounding our planet composed primarily of nitrogen (78%) and oxygen (21%). The remaining 1% consists of water vapour, CO₂ and other trace gasses. The Earth's atmosphere consists of different layers, each one having different properties (temperatures, pressure, composition, etc...).

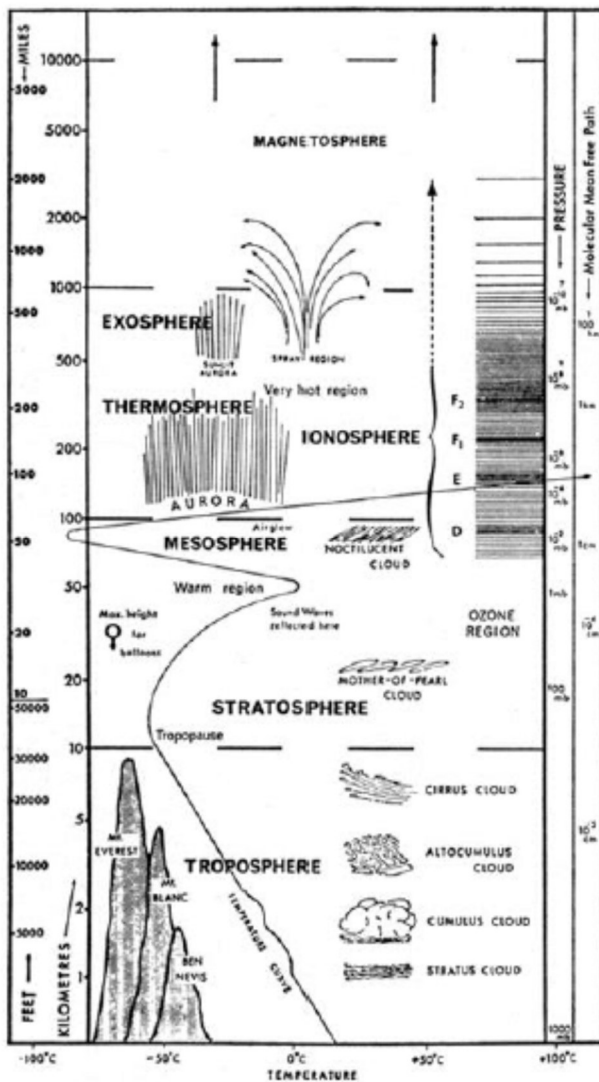

The different layers are represented along with the respective human and weather activities seen in these layers.

Unlike our CanSat, most satellites operate in the exosphere. Here, the density of the atmosphere is extremely low. The CanSat, however, operates in the troposphere, which is the bottom layer of the atmosphere. This layer contains about 80% of the total mass of the atmosphere and stretches to about 10 kilometers altitude. A great deal of the “weather” we observe on a day-to-day basis (e.g. wind and clouds) occurs within this layer.

The temperature and pressure of the atmosphere vary with altitude. Although the ambient temperature can rise and fall as you move through the different layers of the atmosphere, within the troposphere there is a

linear relation between the temperature and altitude. On average, ascending one kilometer from sea level will result in a temperature drop of 6.5 degrees Celsius.

The equation below provides the relation between temperature and altitude:

$$T = T_1 + a(h - h_1)$$

T	Temperature in Kelvin
T_1	Starting temperature at h_1 altitude
h	Altitude in metres
h_1	Starting altitude
a	Temperature gradient: -0.0065 K/m.

The relation between the pressure and the altitude is somewhat more complicated. The pressure not only depends on the altitude but also on the temperature. Let's start with the relation of pressure to temperature:

$$\frac{p}{p_1} = \left(\frac{T}{T_1}\right)^{-\frac{g_0}{\alpha R}}$$

p	Pressure in Pascal
p_1	Start pressure in Pascal
g_0	Gravitational acceleration: $9.81 \frac{m}{s^2}$
R	Specific gas constant: 287.06 J/kg*K

Inserting this formula into the temperature-altitude relationship, we achieve the following expression for altitude as a function of temperature and pressure:

$$h = \frac{T_1}{\alpha} \left(\left(\frac{p}{p_1} \right)^{-\frac{\alpha R}{g_0}} - 1 \right) + h_1$$

Antenna design

Modulation

Radio communication involves sending information from one place to another using electromagnetic waves, which are also called radio waves. Electromagnetic waves are generated at an antenna point when an alternating electric current is connected to it. The antenna transforms the electric current into electromagnetic waves. At the receiving end of the communication, the waves are transformed back into electric current by an antenna.

Using these radio waves to transfer information means that information needs to be added to the respective radio frequency that you are using. Adding this information is called *modulation* and can be done in several ways. The most basic way is to transmit a (*carrier*) frequency (called continuous wave (CW) communication). The most common form of CW is Morse code. The biggest drawback is that the information transfer rate-or *baud rate*-is very low.

There are many other forms of modulation, such as AM and FM, which are used by radio stations. With AM (amplitude modulation), the information is made to change the *amplitude* of the carrier frequency. In FM (frequency modulation), the *frequency* of the carrier is changed. The advantage that FM has over AM is that the signal strength does not interfere with reception.

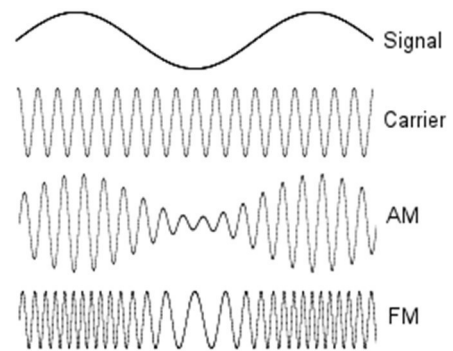

APC220

The APC220 transceiver in the CanSat supports various types of [digital modulation](#). For this project we'll be using Gaussian Frequency Shift Keying (GFSK) which transmits on a certain frequency if a logic 0 is transmitted and a different frequency if a logic 1 is transmitted.

The quality of the radio link mainly depends on three aspects: the transmission power, the receiver sensitivity and the antennas used. The only aspect that can be influenced by the CanSat team is the antenna. The other aspects can be influenced, but that requires a different transmitter and receiver, which is beyond the scope of this project.

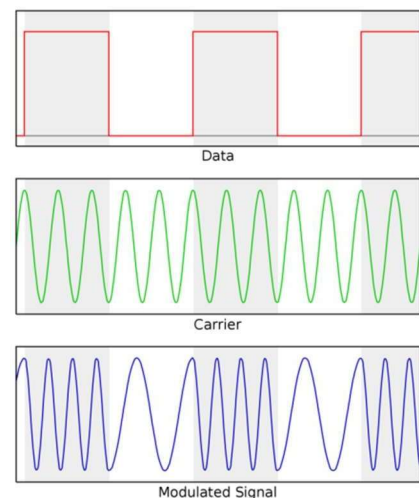

Antennas

There are two antennas used in receiving information from the CanSat: the first will be the antenna on board the CanSat, the second is the antenna used at the ground station. The antennas need to be made with different requirements, although the frequency of operation is similar for both antennas. The antenna on board the CanSat needs to be isotropic-or as much as you can make it-which means that it transmits the same amount of power in all directions. The antenna connected to the ground station can be pointed towards the CanSat, and it can therefore be made as a high-gain directional antenna, which receives more electromagnetic waves from one direction relative to another.

CanSat Antenna

The CanSat antenna needs to be robust enough to survive a rocket launch. For the CanSat, a quarter-wave wire antenna works very well. The quarter-wave describes the length of the antenna in reference to the operation frequency. The CanSat kit transmitter works at around 433 MHz. The precise frequency will depend somewhat on what team you are in. You will get your team frequency from the CanSat organisation. This is done to protect the teams from interference. The required length of the antenna can be calculated using the following equation:

$$L = \frac{c}{4f} = \frac{(3 * 10^8)}{(4 * 433 * 10^6)} = 0.173m$$

in which

L is the required antenna length (1/4 wavelength) in metres

c is the speed of light (300,000 km/s) in metres per second

f is the operating frequency in Hertz

The formula shows that the length of the antenna for 433 MHz should be around 17.3 cm. The wire antenna that came with the CanSat kit should be this length exactly.

Ground station antenna

The ground station antenna can be pointed at the CanSat during flight, which means that it can also be a high gain directional antenna. The most popular antenna design of this type is the Yagi antenna. These are versatile, powerful and can be bought cheaply. For your CanSat, building a Yagi antenna is a good option. They can be constructed relative easily, using wood and copper tubes. There is plenty of information on the internet on building a Yagi antenna.

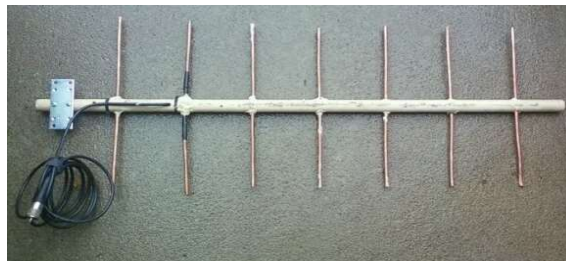
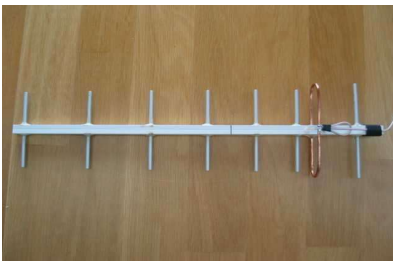

Parachute design

Satellites normally do not return to Earth on a parachute. At the end of its life, a satellite will be put into a different orbit. For satellites orbiting at a low altitude, this could result in burning up in the atmosphere. Satellites further away will end up in a much more distant “parking” orbit. They will circle our planet forever. Sometimes, however, a spacecraft has to return to earth with samples or astronauts. One of the solutions for a safe descend is to make use of a parachute.

When the CanSat is deployed it must have a device to slow it down, otherwise it will crash. Using a parachute will also help to keep the CanSat in an upright position. This is particularly important because it helps to maintain proper antenna orientation, which maximises the chances of receiving telemetry. This section will guide you through the different steps needed to design and build your parachute.

Parachute production

When the design of the parachute is finished, you can start the production process. There are, however, a few important issues to keep in mind. Deployment of the parachute will be relatively violent, so the fabric and fibres you use need to be strong. You can usually reinforced buy nylon cord and ripstop fabric at a kite shop. These are not only inexpensive but they may help you immensely in strengthening your final parachute.

When cutting the fabric, remember that some of the fabrics need to be folded back in order to sew seams.

More handy tips on parachute production can be found at:

www.nakka-rocketry.net/paracon.html

When your parachute has been successfully completed, the next step will be to check if it works is to test it.

Example assignments

The following tests can be carried while working on your parachute.

- Calculate the impact speed of the can without a parachute (when released from 1 kilometer altitude).
- Calculate what the minimum required total area for your parachute might have to be to a cross parachute design. What size should the squares be on the chute?
- Perform the same calculation for a theoretical round parachute. What would its radius have to be?
- Test the descent velocity of your parachute with a soda can.
- Try out different solutions for the parachute. A parachute with holes in it or perhaps multiple small parachutes could provide a solution. Both will enhance the stability of the CanSat.

Descent physics

Before we can start making the parachute, we will have to officially figure out how big it should be. More specifically, we need to calculate how much surface area the parachute will need in order to fulfil the requirements. This is where your work from the above section will come in handy

Logic suggests that the bigger the parachute, the slower the object’s descent velocity. This principle is shown below with some basic equations. Although it would usually be better for a satellite to have a very slow rate of descent, a limit for the Cansat project has to be set for this rate to ensure that the CanSat will land near the launch area. If the descent rate is too slow, the CanSat may drift kilometers away along in the wind, which is neither allowed nor helpful. To truly be able to collect data with your antenna you’ll need to abide by the minimum descent rate that has been set:

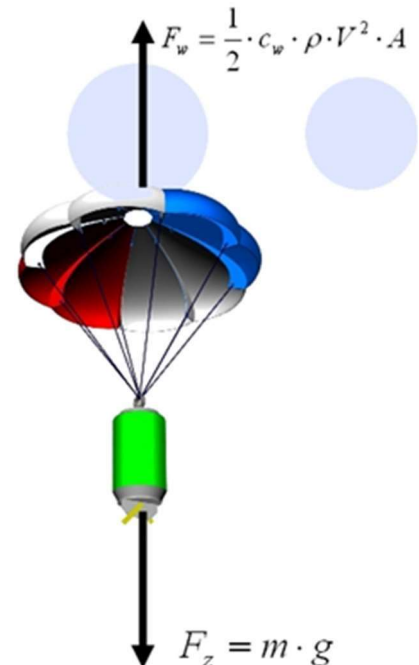

On lift-off, the launcher will reach an altitude of 900 to 1000 metres within 13 seconds. Here, it will deploy all of the CanSats. The whole process-from lift off to touchdown-has to happen within 90 seconds. This only leaves 77 seconds for your CanSat to descend 1000 metres. This is the most critical stage for your recovery system. If your CanSat cannot meet this limit, it will not be approved. It is therefore critical that your parachute (or whatever you are using) does not fail during these 77 seconds.

To design the parachute, we will use some basic physics. We use a simplified equation to estimate the area of the parachute, after which we can start its assembly.

During the descent, two forces will be acting on the CanSat. Gravity will pull on the can and accelerate it towards the ground and the drag force on the parachute will pull the CanSat in the opposite direction and slow down the descent rate.

When the CanSat is deployed, the force of gravity will cause it to accelerate. After a few seconds, the drag force from the parachute will reach equilibrium with the force of gravity. From that point on, the acceleration will be zero and the CanSat will descend at a constant velocity. This constant velocity has to be greater than the minimum descent velocity specified in the requirements section of the project below. For the following calculations, we can use this minimum value as the constant velocity of the CanSat.

The gravity force is equal to:

$$F_g = m * g$$

In this equation

m is the mass of the CanSat in kilograms

g is the acceleration of gravity, equal to $9.81 \frac{m}{s^2}$

The drag force of the parachute is equal to:

$$F_D = 0.5 * C_D * \rho * A * V^2$$

In this equation:

A is the total area of the parachute (not just the frontal area)

C_D is the drag coefficient of the parachute. This value depends on the shape of the parachute.

ρ is the local density of the air, assumed to be constant at $1.225 \frac{kg}{m^3}$

V is the descent velocity of the CanSat

Given your desired velocity, you can easily manipulate these equations to calculate the area needed for the parachute.

Required descent parameters

Minimal descent Velocity: 13 m/s

Maximum allowed mass: 0.350 kilograms

Drag coefficient: When designing the size of your parachute, you can assume the drag coefficient to be 0.4.

To calculate the area of your parachute you have to take the full production area of your parachute into account. For instance, if you are making a cross parachute, you have to use the area of the full cross laid flat. Not the area seen when a parachute is drawn.

Semi-spherical parachute design

A semi-spherical appearance is the most common shape for a parachute. Although it is not hard to make one, it can be quite time-consuming to get the right shape. The figure below should help.

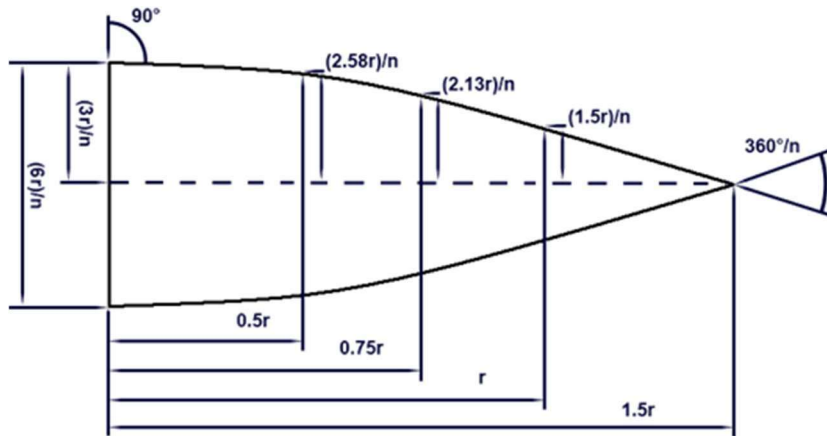

n = stands for the number of parts needed

r = stands for the radius of the parachute.

Cross parachute design

Instead of using a semi-spherical-shaped parachute, you can also choose a cross shape. The advantage of this shape is that it's easy to make. If you want to know more about cross-shaped parachutes, you can check the following link:

www.nakka-rocketry.net/xchute1.html



Parapent

A parapent shaped parachute acts rather like a wing. Because of its shape you can use it to steer. The design of a parapent is more complex than that of the other shapes mentioned. You will have to do some more research if you wish to use this type of parachute.



Flat parachute design

The most commonly available parachutes are in fact created from standard two-dimensional flat geometric figures, such as hexagons or octagons.

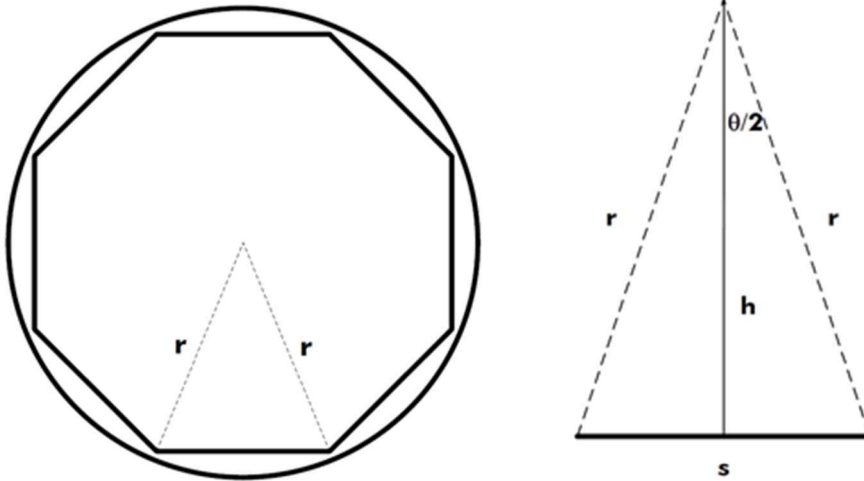

From above, you can see that the parachute consists of 8 equal triangles. Hence, the total area for the parachute would be $A = 8 * AT$, where the area of one triangle is $AT = s * \frac{h}{2}$. By combining these two equations, we get $A = \frac{8*s*h}{2}$. You can read more about how to calculate the area of a flat parachute at:

www.sunward1.com/imagespara/The%20Mathematics%20of%20Parachutes%28Rev2%29.pdf

As soon as you know the total area (A) together with the drag coefficient (C_D), you can easily determine the descent rate for your CanSat. Perform some drop tests to check if your calculations are accurate and to find the terminal velocity.

Other recovery systems

There are also different options when recovering an object. The Mars Exploration Rover, for instance, used airbags for its landing on Mars (see below). This was based on the same principle as a parachute, namely increasing area to increase drag and therefore slow down the vehicle. Airbags have the additional advantage that they soften the landing.



Apart from these systems, there are also recovery systems that use lift-induced drag. This type of drag is used in airplanes and helicopters. Auto rotation, a recovery system researched by many including NASA, is based on the movement of helicopter blades. One big advantage of this system would be that it is steerable to a certain location. An example of these blades is shown in the figure below.

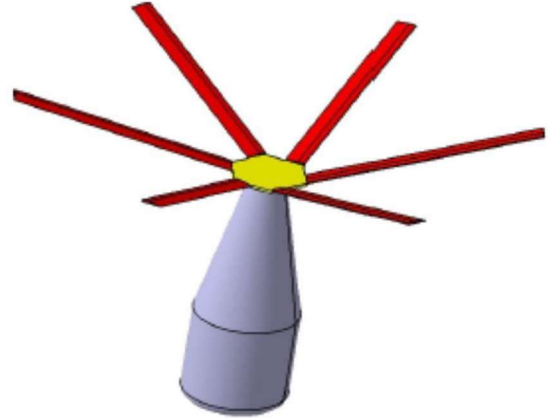
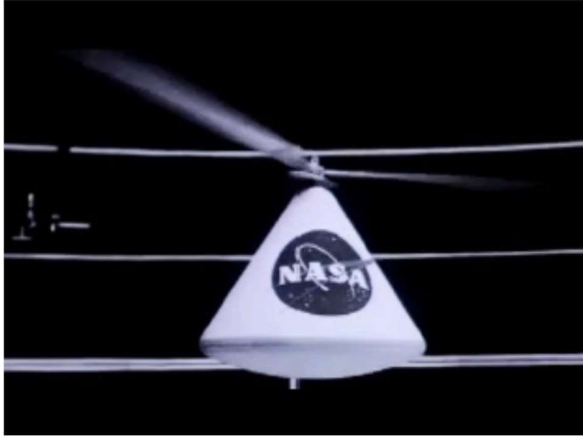

CanSat Competition tips

Based on experiences of teams competing in CanSat competitions throughout the years we would like to offer you some extra tips and tricks to get you well prepared for the CanSat competition.

Our tips for CanSat design:

- The temperature sensor for your primary mission must measure the air temperature *outside the CanSat*. If the sensor is hidden away too much within your CanSat, the measuring results may be impacted so far as to yield no proper data. Take this into account in your CanSat design.
- During previous launching events, it became clear that CanSats are difficult to trace in the heathland of the testing site; this to make recovering them after launch much harder. As a result many CanSats were never recovered. Using a sound signal (e.g. a beeper) as a recovery system increases the likelihood of recovery. This recovery, however, will be not be done by your team but by military personnel from ASK 't Harde, so keep this in mind
- Use a bright colour for your parachute that contrasts sharply with grassland. This will improve your chance of being able to see your CanSat easily during the flight and being able to follow it with your Yagi antenna.

Tips from participants in former competitions:

- The most important tip: prepare well, start on time, plan out every step in the process well! Keep in mind that you'll need a lot of time. Manage your time well. Be organised and work hard.
- Make a good plan for how you'll divide tasks within your team. Make sure everybody knows his or her tasks and responsibilities.
- Communicate: talk to each other regularly about how things are going and have the courage to talk to each other about how you might improve distinct part of your project.
- Research well before you choose a secondary mission. Check to see if it is realistic and feasible.
- Test, test, test. Test everything thoroughly and often (under different circumstances): test and check your design. Make sure it meets the requirements.
- If you encounter a problem that you cannot solve, ask for help on time (from your teacher for example).
- Bring your tools to the test and launch days in case something does go wrong or needs fixing on site (e.g. last minute soldering of wires).
- Giving up is not an option. If you experience any setbacks, always continue. Think differently about finding solutions instead of focussing problems. Persevere and you will succeed!
- And don't forget to have fun! We can't wait to see you on launch day

Outreach programme & communication

During the competition, each team's efforts will be judged on scientific relevance, technical achievements and innovative aspects. The success of a CanSat project, however, relies on more than just technical skills! Teamwork and outreach (on social media along with other media coverage) are also important aspects of a space project, and will therefore be assessed too.

Some handy info, tips and tricks to use when communicating about the project.

Public relations and free publicity

What can you do to get some free publicity about the CanSat project and your team?

Basic information about the project & partners

First things first: get the basics right. Journalists often make mistakes when writing about the CanSat project organization and partners. Always provide the following information on the CanSat competition:

CanSat is an ESERO project executed by NEMO on the instructions of the Netherlands SpaceOffice (NSO). The aim of the competition is to spark young people's enthusiasm for a career in technology.

CanSat is een ESERO-project dat NEMO uitvoert in opdracht van het Nederlands ruimtevaartagentschap Netherlands Space Office. Defensie is logistiek partner tijdens de testdag en het lanceerevenement. De competitie is opgezet om scholieren enthousiast te maken om voor een technische opleiding te kiezen

Please note: always use capital letters when mentioning ESERO, NEMO and NSO. Go to www.esero.nl/cansat for more information about the project.

Social Media

Consider creating a team profile on Facebook, Instagram or Twitter, and invite family, friends and classmates to follow you and share your posts. Pictures, short movies and personal stories about your team work best.

Select the right hashtags: #cansat, #cansatNL #cansatcompetition #ESERO. Tag on Twitter: @eseroNL, @NEMOamsterdam and @NSO. Tag on Facebook and Instagram: @nemosciencemuseum. We will then be able to like your posts. And be sure to follow us and to share our posts about the competition!

Website/blog

You may wish to create your own website or blog where you can provide information about your team's activities and developments during the project.

Press

You can reach out to the press (local newspapers, websites, radio and TV stations) to promote the CanSat project, your team and your mission. We recommend contacting local press outlets, as they are more likely to pick up your story than the national press.

You could issue a press release. Some tips:

- Answer the 5 Ws + H in the headline and the first paragraph of your press release:
- who, what, where, why, when and how.
- Provide details and background information in the subsequent paragraphs.
- Each paragraph should contain no more than one main message.
- Give your press release an inviting headline and sub-headings that will intrigue the reader.
- Use quotes from your teammates or your teacher to enliven your press release.

- Restrict your press release to a single A4 sheet: stick to the essence and be prepared to delete.
- Do not use jargon; outsiders should be able to understand your text.
- Use active verb forms in your press release.
- Check carefully for spelling and other language errors.
- Ask someone else to give the text a critical read-through, preferably someone who is not familiar with the topic.
- Include a 'note to the editors' at the end of your press release indicating who the press can contact for more information. Include a telephone number and e-mail address.
- Image materials are very important, so be sure to include high-quality photos with your press release, preferably in landscape (horizontal) format.
- Try to get the names of journalists to whom you can send your press release. Journalists are more likely to pick up personally addressed press releases. After sending the press release, you can also call a journalist to ask if they have received it and if they can use it.
- Don't forget to send your press release to pers@e-nemo.nl so that we are in the loop.